

CARGO RESTRAINT TRACKS

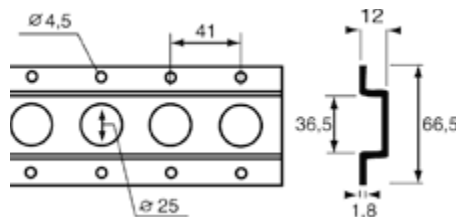

TRACK 1805

APPLICATION:
Light duty track suitable for horizontal and vertical wall mounting and roof installation. Compatible with Load-Lok shoring poles, garment rails and securing straps with 1821, 1827 and 1828 end fittings.



Art.nr.	Length in mm	Material	Weight
18051,812	3000	Mild Steel + Pre-Galvanised or Zinc Plated	2 ⁸ kg

TRACK 1805-RVS-2 (Stainless Steel)

APPLICATION:
Light duty track suitable for horizontal and vertical wall mounting and roof installation. Compatible with Load-Lok shoring poles, garment rails and securing straps with 1821, 1827 and 1828 end fittings. Also available in Stainless Steel 304 (Art. nr. 18052,030412). Suitable for temperature controlled transport.

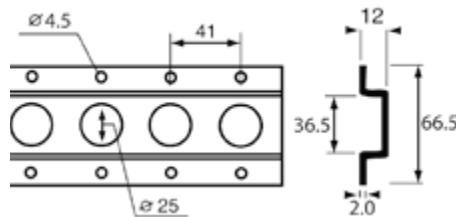

Art.nr.	Length in mm	Material	Weight
18052,043012	3000	SS 430	3 kg

TRACK 1805-RVS-2,5 (Stainless Steel)

APPLICATION:
Medium duty track suitable for horizontal and vertical wall mounting and roof installation. Compatible with Load-Lok shoring poles, garment rails and securing straps with 1821, 1827 and 1828 end fittings. Suitable for temperature controlled transport.

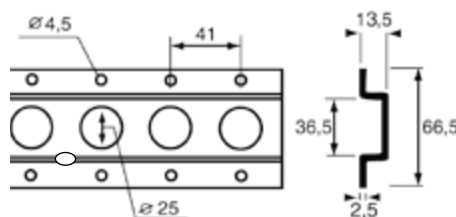

Art.nr.	Length in mm	Material	Weight
18052,530413,5	3000	SS 304	4 ⁷ kg

CARGO RESTRAINT TRACKS

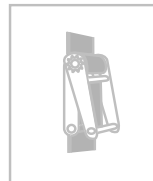
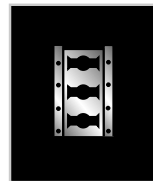
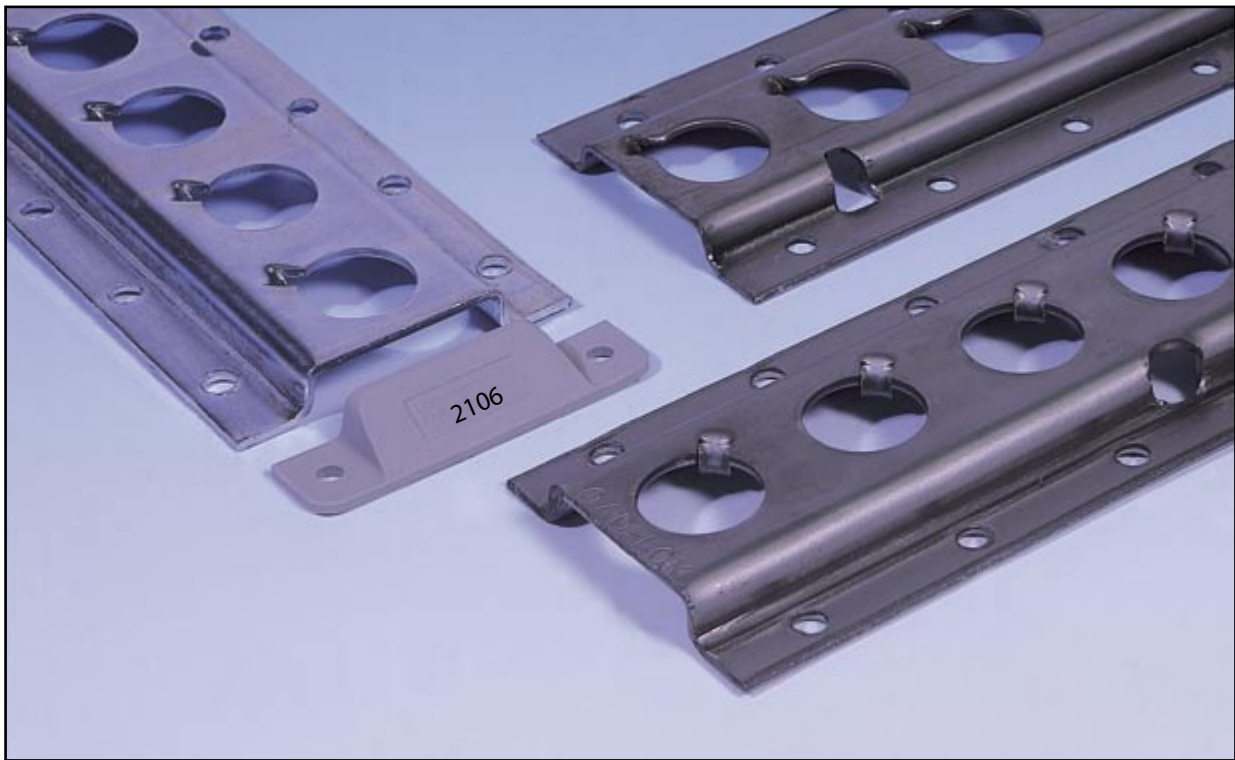

TRACK 1806

APPLICATION:
Medium duty track suitable for horizontal and vertical wall mounting.
Compatible with Load-Lok shoring poles, garment rails, securing straps with end fittings 1823, 1827 & 1828 and decking beam brackets 1844.

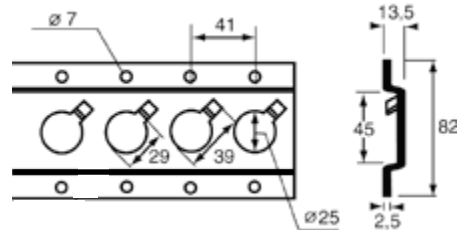

Art.nr.	Length in mm	Material	Weight
18062,513,5	3000	Mild Steel + Zinc Plated	4 ⁵ kg

TRACK 1806-RVS-2 (Stainless Steel)

APPLICATION:
Medium duty track suitable for horizontal and vertical wall mounting.
Compatible with Load-Lok shoring poles, garment rails, securing straps with end fittings 1823, 1827 & 1828 and decking beam brackets 1844.
Suitable for temperature controlled transport.

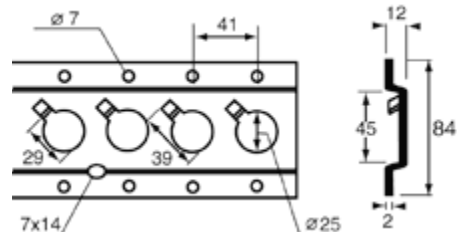

Art.nr.	Length in mm	Material	Weight
18062,043012	3048	SS 430	3 ⁵ kg

TRACK 1806-RVS-2,5 (Stainless Steel)

APPLICATION:
Medium duty track suitable for horizontal and vertical wall mounting.
Compatible with Load-Lok shoring poles, garment rails, securing straps with end fittings 1823, 1827 & 1828 and decking beam brackets 1844.
Suitable for temperature controlled transport.

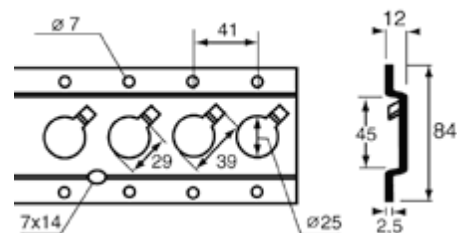

Art.nr.	Length in mm	Material	Weight
18062,543012	3048	SS 430	4 ³ kg

CARGO RESTRAINT TRACKS

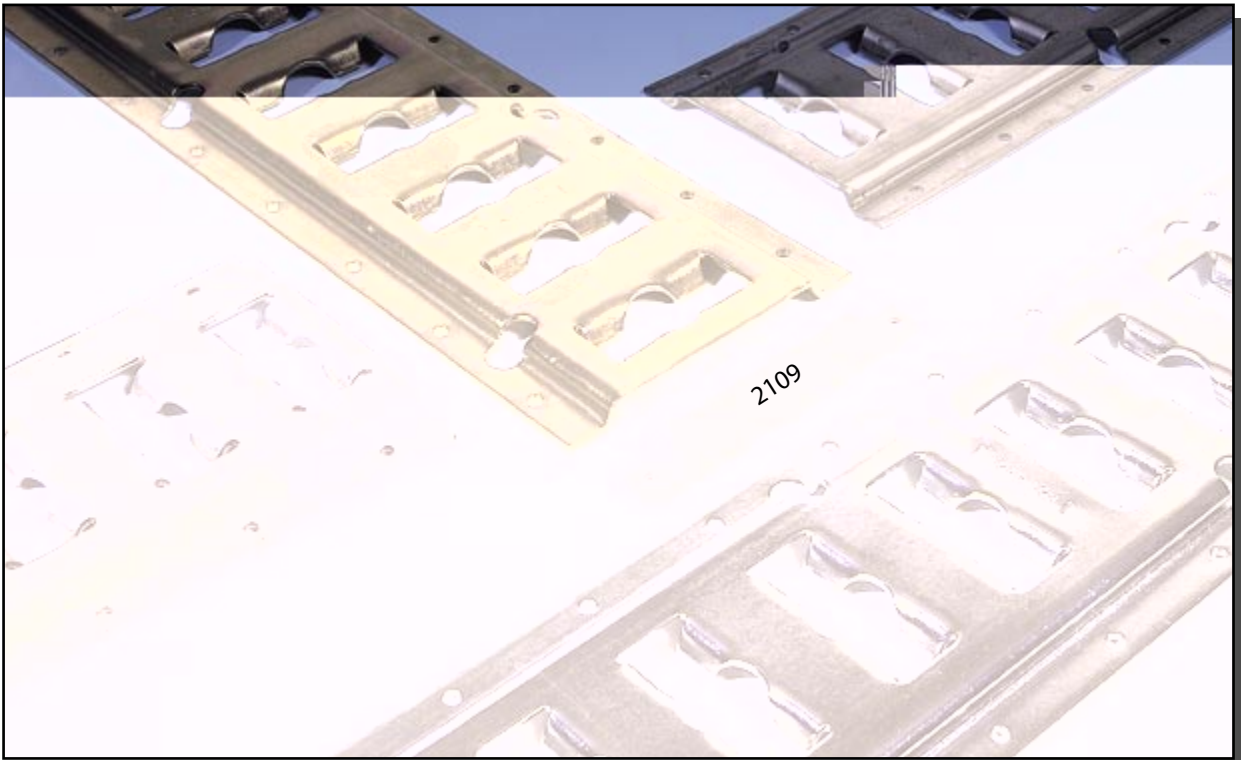

TRACK 3009

APPLICATION:

Medium duty track suitable for horizontal wall mounting. Compatible with Load-Lok shoring poles, garment rails, decking beams, 1845 & 1846 decking beam brackets and securing straps with 1825 and 1826 end fittings.

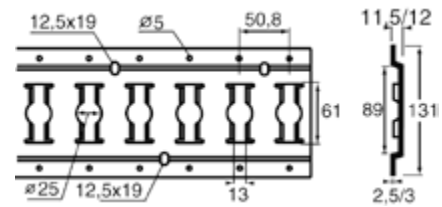

Art.nr.	Length in mm	Material	Weight
30092,511,5	3048	Mild Steel + Zinc Plated	7 ¹ kg
30093,012	3048	Mild Steel + Zinc Plated	8 ¹ kg

TRACK 3009 RVS (Stainless Steel)

APPLICATION:

Medium duty track suitable for horizontal wall mounting. Compatible with Load-Lok shoring poles, garment rails, decking beams, 1845 & 1846 decking beam brackets and securing straps with 1825 and 1826 end fittings. Suitable for temperature controlled transport.

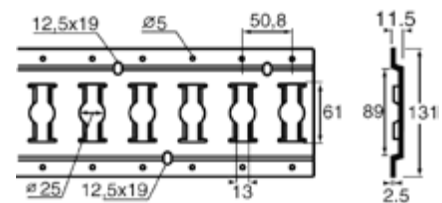

Art.nr.	Lengte in mm	Materiaal	Gewicht
30092,543011,5	3048	RVS 430	6 ⁷ kg

TRACK 3009 AL (Aluminium)

APPLICATION:

Heavy duty track suitable for horizontal wall mounting. Compatible with Load-Lok shoring poles, 3009 garment rails, decking beams, 1845 & 1846 decking beam brackets and securing straps with 1825 and 1826 end fittings.

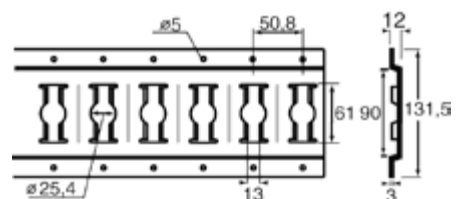

Art.nr.	Length in mm	Material	Weight
30093,0AL12	3048	Aluminium	3 kg

CARGO RESTRAINT TRACKS

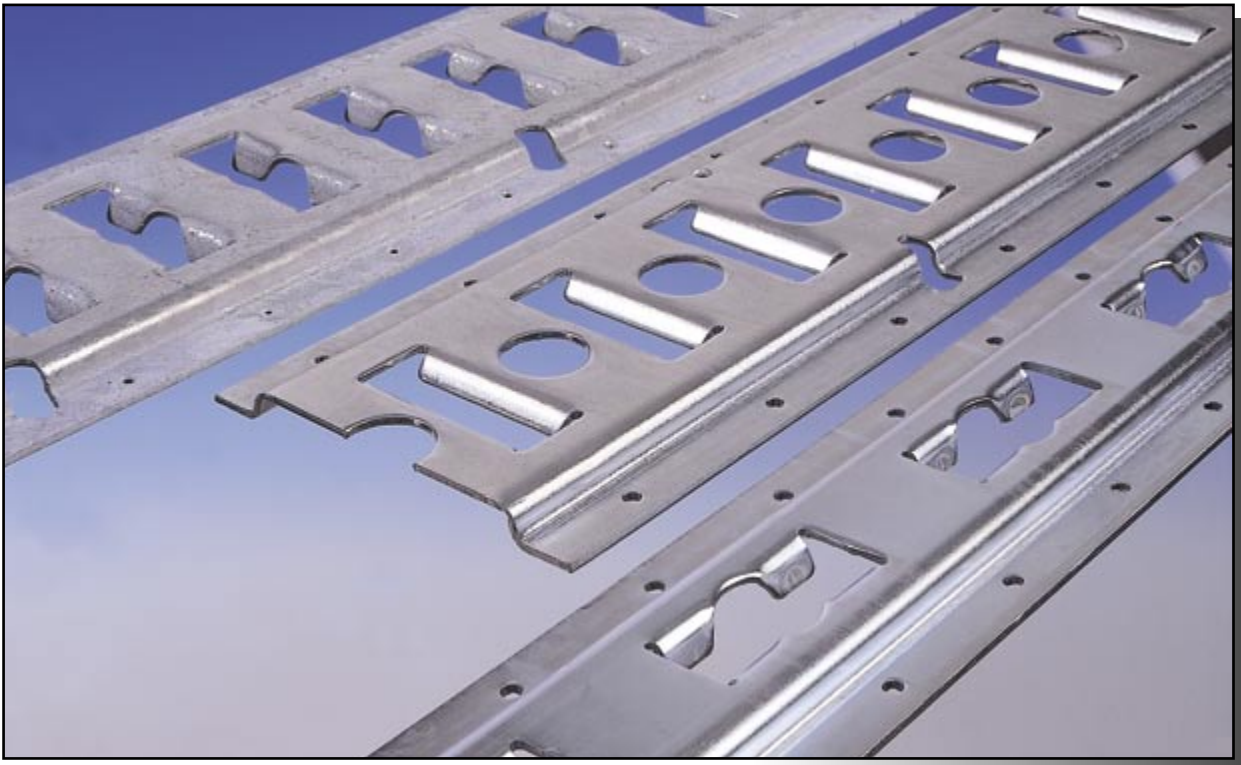

TRACK 3009 TV

APPLICATION:

Medium duty track suitable for horizontal wall mounting. Compatible with Load-Lok shoring poles, garment rails, decking beams, 1845 & 1846 decking beam brackets and securing straps with 1825 and 1826 end fittings. Suitable for temperature controlled transport of packed p[roducts].

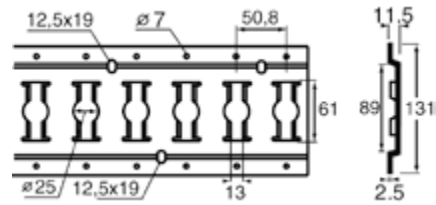

Art.nr.	Length in mm	Material	Weight
30092,5TV11,5	3048	Mild Steel + Hot Dip Galvanised	7 ² kg

TRACK 3008

APPLICATION:

Medium duty track suitable for horizontal wall mounting. Compatible with Load-Lok shoring poles, garment rails, decking beams, 1845 & 1846 decking beam brackets and securing straps with 1821, 1825, 1826 and 1827 end fittings. Suitable for temperature controlled transport of packed p[roducts].

*) On request also available in stainless steel grades 430 or 304.

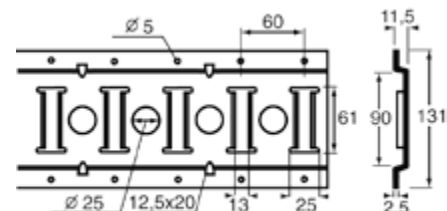

On request also available with Ø 20 mm holes

Art.nr.	Length in mm	Material	Weight
30082,511,5	3000	Mild Steel + Zinc Plated*	7 ⁹ kg

VERTICAL TRACK 2010

APPLICATION:

Heavy duty suitable for vertical wall mounting. Compatible with Load-Lok shoring poles, garment rails, 1839 & 1839HD decking beams, 1845 & 1846 decking beam brackets and securing straps with 1825 and 1826 end fittings.

*) On request also available in stainless steel grades 430 or 304.

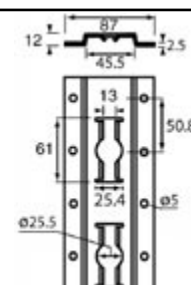

Art.nr.	Length in mm	Material	Gewicht
20102,512	3048 or 2440	High Yield Steel + Zinc Plated*	5 ^{1/4} kg

CARGO RESTRAINT TRACKS

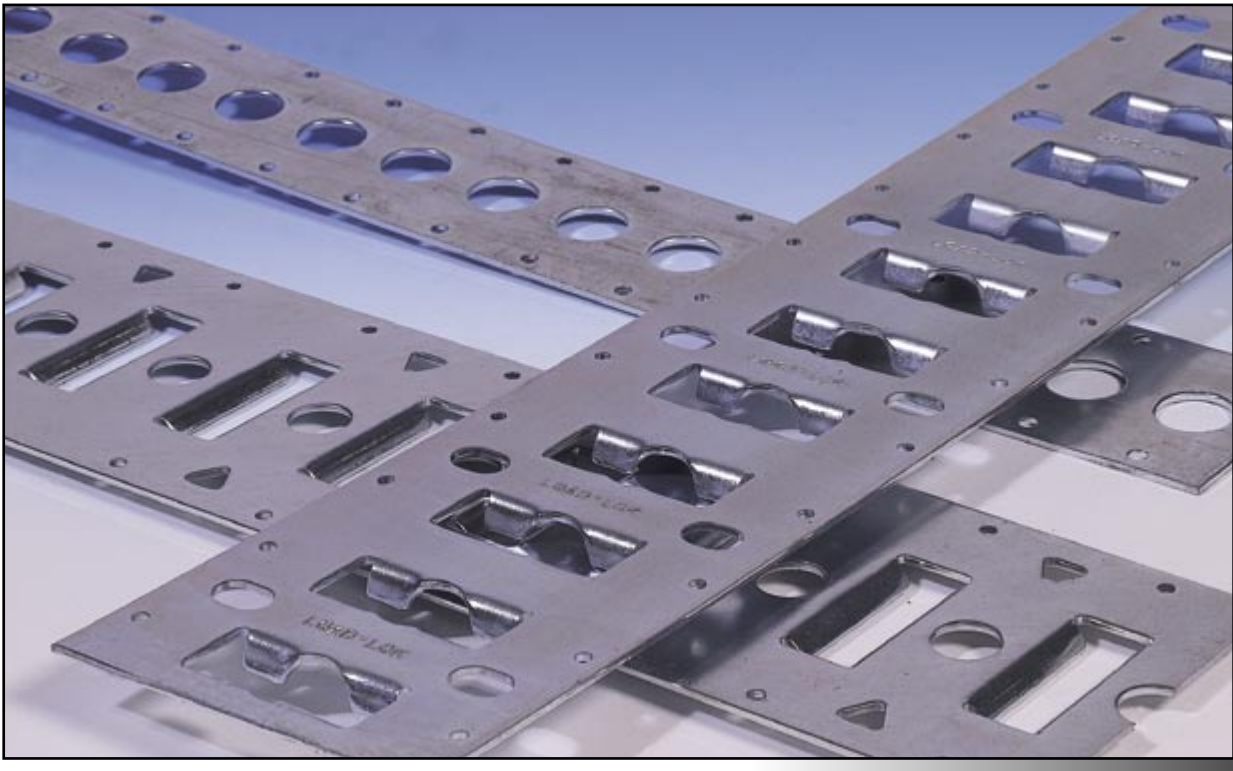

FLAT TRACK 3009 FL

APPLICATION:

Heavy duty FLAT flush fitting track suitable for horizontal wall mounting to recessed panels. Compatible with Load-Lok shoring poles, garment rails, decking beams, 1845 & 1846 decking beam brackets and securing straps with 1821, 1825 and 1826 end fittings.

*) On request also available in stainless steel grades 430 or 304.

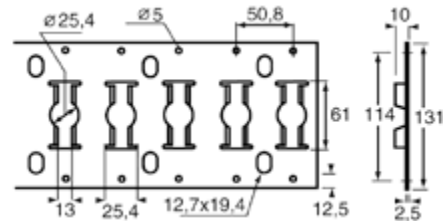

Art.nr.	Length in mm	Material	Weight
30092,5FL	3048	Mild Steel + Zinc Plated*	6 ⁵ kg

FLAT TRACK 3008 FL

APPLICATION:

Heavy duty FLAT flush fitting track suitable for horizontal wall mounting to recessed panels. Compatible with Load-Lok shoring poles, garment rails, decking beams, 1845 & 1846 decking beam brackets and securing straps with 1821, 1825, 1826 and 1827 end fittings.

*) On request also available in stainless steel grades 430 or 304.

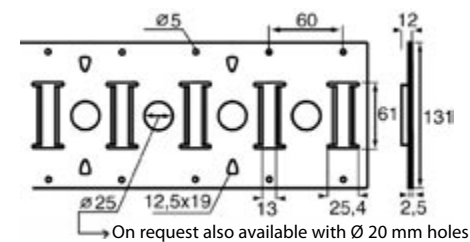

Art.nr.	Length in mm	Material	Weight
30082,5FL	3000	Mild Steel + Zinc Plated*	6 ⁵ kg

FLAT TRACK 1805 FL

APPLICATION:

Medium duty FLAT flush fitting horizontal and vertical track suitable for wall mounting to recessed panels. Also suitable for floor mounting. Compatible with Load-Lok shoring poles, garment rails and securing straps with 1821 and 1827 end fittings.

*) On request also available in stainless steel grades 430 or 304.

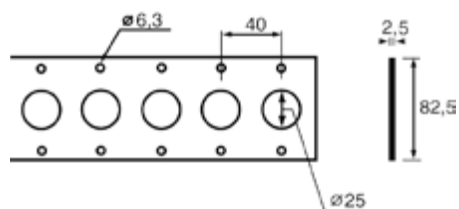

Art.nr.	Length in mm	Material	Weight
18052,5FL	3000	High Yield Steel + Zinc Plated*	4 ⁴ kg

CARGO RESTRAINT TRACKS

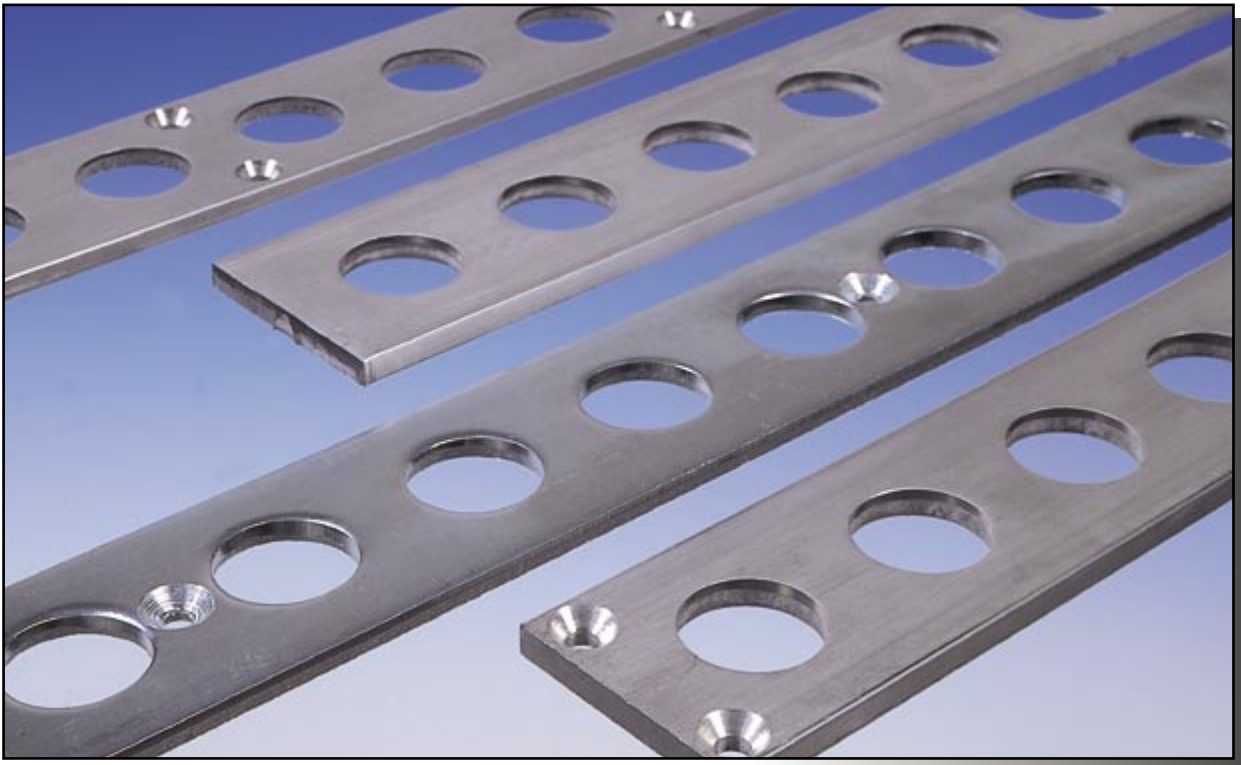

FLOOR TRACK 3003/4 ST

APPLICATION:
Heavy duty flush fitting flat track for floor mounting. Compatible with Load-Lok shoring poles.

Countersunk fixing holes-non-standard-only available on request.

Art.nr.	Length in mm	Material	Weight
3003ST04	3000	4mm Mild Steel + Zinc Plated	3 ⁵ kg
3004ST05	3000	5mm Mild Steel + Zinc Plated	4 ² kg

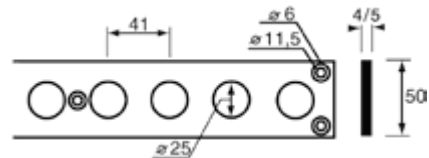

FLOOR TRACK 3003 RVS (Stainless Steel)

APPLICATION:
Heavy duty flush fitting stainless steel flat track for floor mounting. Compatible with Load-Lok shoring poles.
Suitable for temperature controlled transport.

Art.nr.	Length in mm	Material	Weight
300330404	3000	SS 304	2 ⁹ kg

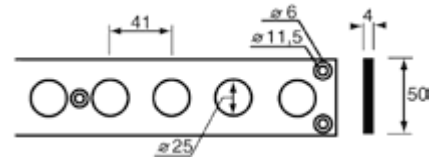

FLOOR TRACK 3004 AL

APPLICATION:
Heavy duty flush fitting aluminium flat track for floor mounting. Compatible with Load-Lok shoring poles.

Art.nr.	Length in mm	Material	Weight
3004AL05	3000	Aluminium	1 ⁶ kg
3004AL06	3000	Aluminium	1 ⁸ kg

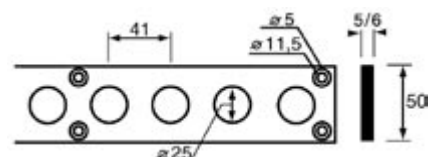

CARGO RESTRAINT TRACKS



FLOOR TRACK 3010 & ROOF TRACK 3011

APPLICATION:

3010

Heavy duty floor track for flush recessed mounting directly onto floor bearers. 3010 is fitted with a base plate. Compatible with Load-Lok shoring poles.

3011

Heavy duty roof track. Compatible with Load-Lok shoring poles.

*) On request also available in stainless steel.

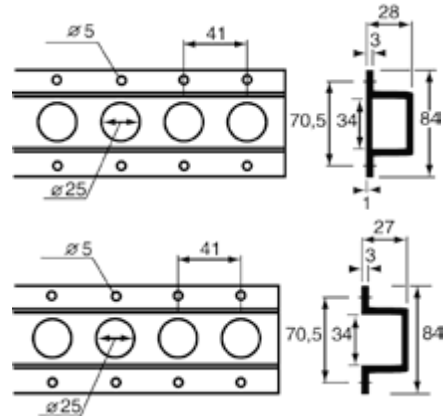

Art.nr.	Length in mm	Material	Weight
30103,028	3000	M/S & Zinc plated*	9 ³ kg
30113,027	3000	M/S & Zinc plated*	7 ³ kg

FLOOR TRACK 3005 & ROOF TRACK 3006

APPLICATION:

3005

Medium duty and heavy duty floor track for flush recessed mounting directly onto floor bearers. 3005 is fitted with a base plate. Compatible with Load-Lok shoring poles.

3006

Medium duty and heavy duty roof track. Compatible with Load-Lok shoring poles.

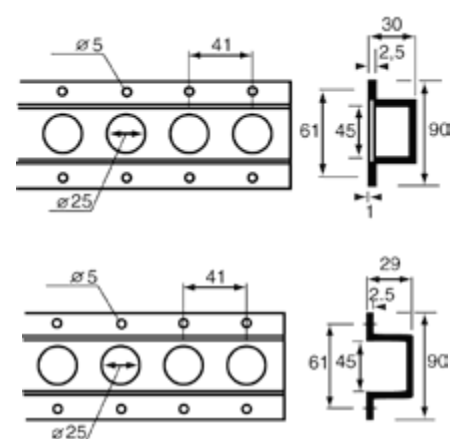

Art.nr.	Length in mm	Material	Weight
30052,530	3000	M/S & Zinc plated	9 kg
30062,529	3000	M/S & Zinc plated	6 ⁷ kg

CARGO RESTRAINT TRACKS

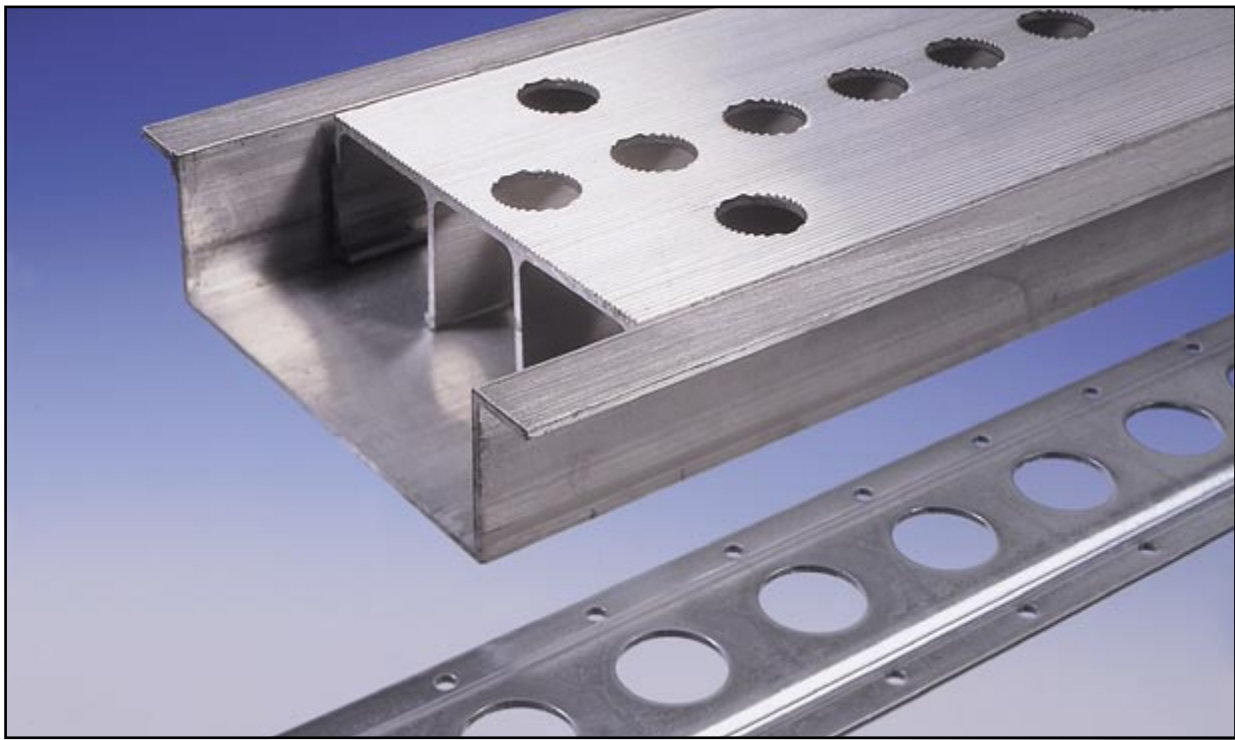

EXTRA LOW FLOOR TRACK 3002

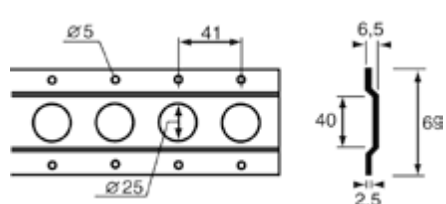
<p>APPLICATION: Heavy duty Ultra Low floor track. Compatible with Load-Lok shoring poles with shortened end plug.) On request also available with a hot dipped galvanised finish. (30022,5TV06,5)</p>				
Art.nr.	Length in mm	Material	Weight	
30022,506,5	2993	Mild Steel + Zinc Plated*	3 ⁶ kg	

HEATING + SECURING TRACK 3020

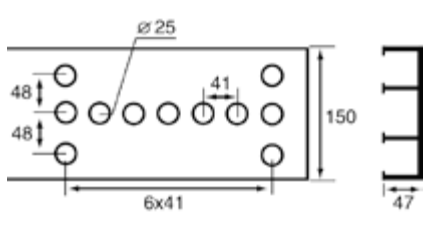
<p>APPLICATION: Floor mounted ducted warm air heating track and load securing track 3020 seats into 3030 ducting profile and is easily removed and reinstalled to allow cleaning. The system is compatible with Load-Lok shoring poles.</p>				
Art.nr.	Length in mm	Material	Weight	
3020AL	5000	Aluminium	14 ² kg	

DUCTING 3030

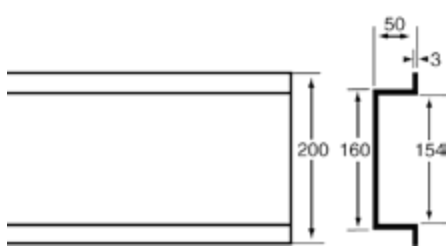
<p>APPLICATION: Floor mounted warm air ducting profile for 3020 track.</p>				
Art.nr.	Length in mm	Material	Weight	
3030AL	5000	Aluminium	11 ⁶ kg	

CARGO RESTRAINT TRACKS

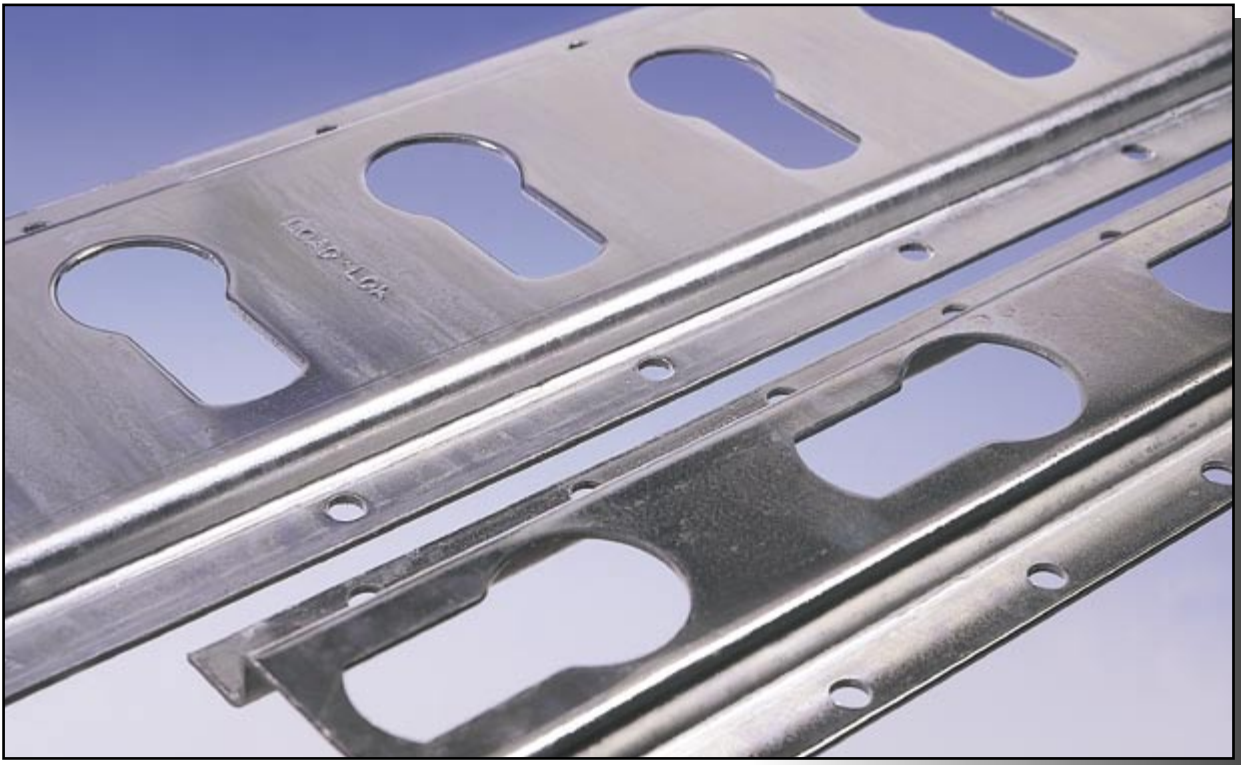

TRACK 1803 HORIZONTAL

<p>APPLICATION: Key Hole track suitable for horizontal wall mounting. Compatible with Load-Lok garment rails, shoring poles, 1845 & 1846 decking beam brackets and strap assemblies with 1825 and 1826 end fittings. *) On request also available in <u>stainless steel</u> grades 430 or 304.</p>			
Art.nr.	Length in mm	Material	Weight
1803H2,012	3000	High Yield Steel & Zinc plated*	57 kg

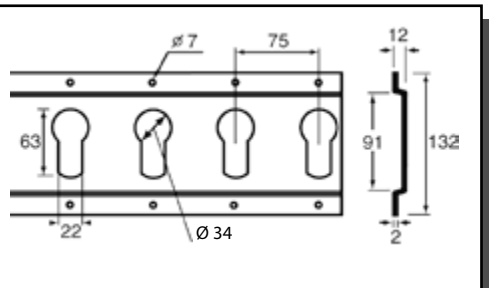

TRACK 1803 VERTICAL

<p>APPLICATION: Key Hole track suitable for vertical wall mounting. Compatible with Load-Lok garment rails, shoring poles, 1845 & 1846 decking beam brackets and strap assemblies with 1825 and 1826 end fittings. *) On request also available in <u>stainless steel</u> grades 430 or 304.</p>			
Art.nr.	Length in mm	Material	Weight
1803V2,012	3000	High Yield Steel & Zinc plated*	3 ⁹ kg

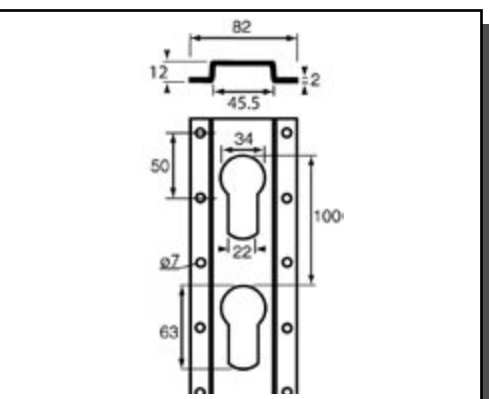

CARGO RESTRAINT TRACKS



TRACK 3100

APPLICATION:
Suitable for horizontal mounting in furniture removal vehicles. The double slot allows endless webbing straps to be threaded through along its length removing the need for metal end fittings. The shoring hole of 22 mm requires special Load-Lok shoring poles.

Art.nr.	Length in mm	Weight	Gewicht
3100208	5850	M/S & Zinc plated	7 ⁶ kg
3100215	5850	M/S & Zinc plated	8 ⁷ kg

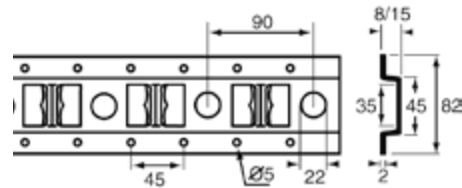

LASHING RAIL 3115

APPLICATION:
Suitable for horizontal mounting in furniture removal vehicles. Compatible with endless webbing straps and straps with 1011 hooks. Also available in *6000mm lengths.

This track can be P.V.C. covered as shown above.

Art.nr.	Length in mm *	Material	Weight
3115PVC	3000	Aluminium + PVC	4 ³ kg
3115	3000	Aluminium	3 ³ kg

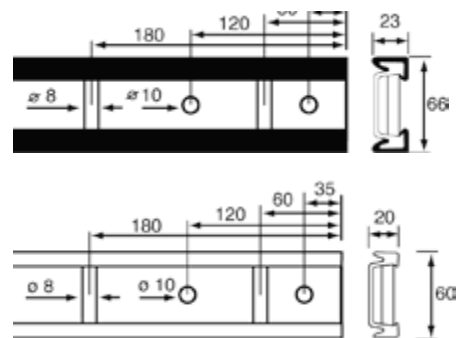

LASHING RAIL 3114

APPLICATION:
Suitable for horizontal mounting in furniture removal vehicles. Compatible with endless webbing straps and straps with 1011 hooks.
Art.nr. 3119 (shown in the picture on top of this page) is a very light duty version.

Art.nr.	Length in mm	Material	Weight
3114	5840	Aluminium	4 ⁵ kg

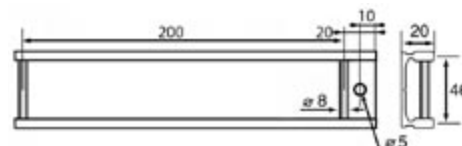

CARGO RESTRAINT TRACKS

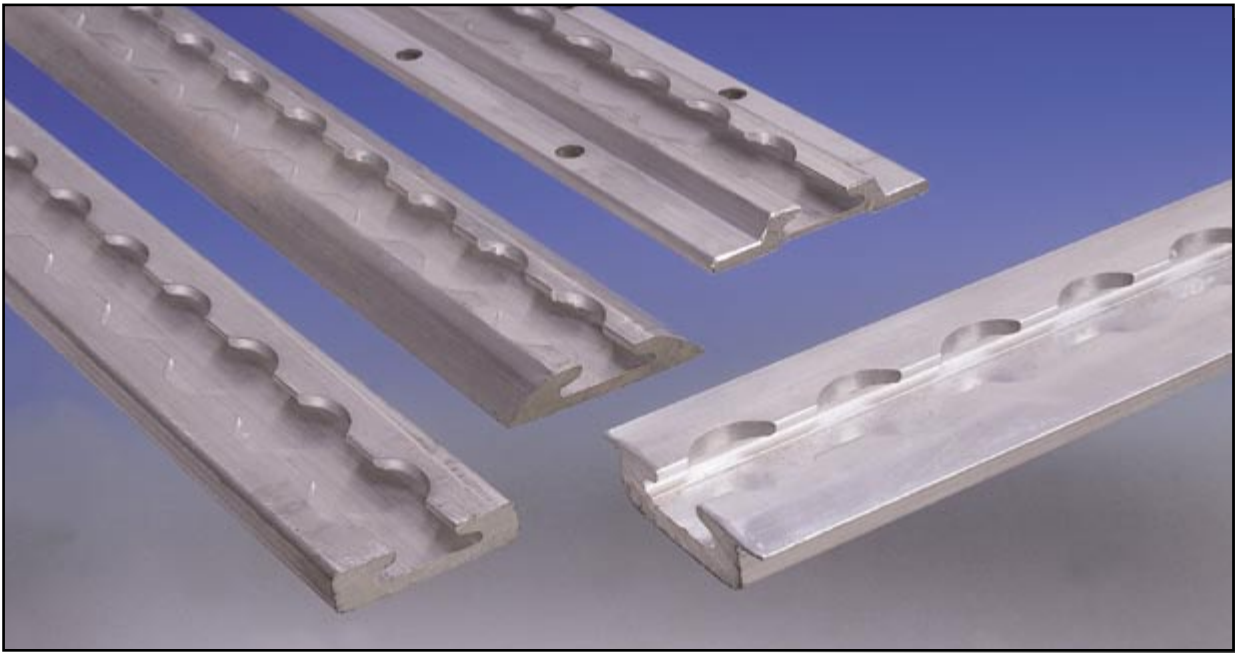

CAPTIVE TRACK 5001

<p>APPLICATION: Heavy duty aluminium captive track suitable for horizontal wall and floor mounting. Compatible with strap assemblies with 5012, 5013, 5014, 5018 & 5030 end fittings.</p>			
Art.nr.	Length in mm	Material	Weight
5001	3000	Aluminium	1 ⁹ kg

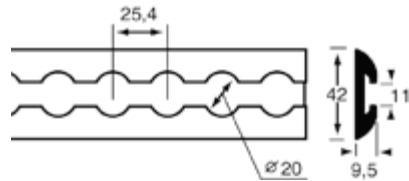

CAPTIVE TRACK 5002

<p>APPLICATION: Heavy duty aluminium captive track suitable for horizontal wall and floor mounting. Compatible with strap assemblies with 5012, 5013, 5014, 5018 & 5030 end fittings. Especially suited for Wheelchair restraint systems, computer transport, air cargo and public address system rigging.</p>			
Art.nr.	Length in mm	Material	Weight
5002	3000	Aluminium	1 ⁷ kg
5002-HD	3000	Aluminium	2 ⁶ kg

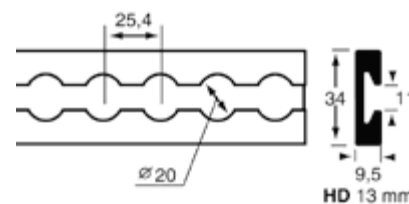

CAPTIVE TRACK 5004

<p>APPLICATION: Heavy duty aluminium captive track suitable for horizontal wall and floor mounting. Compatible with strap assemblies with 5012, 5013, 5014, 5018 & 5030 end fittings. Especially suited for Wheelchair restraint systems, computer transport, air cargo and public address system rigging.</p>			
Art.nr.	Length in mm	Material	Weight
5004	3000	Aluminium	2 ⁶ kg

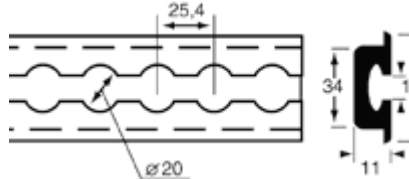

CAPTIVE TRACK 5008SPEC

<p>APPLICATION: Heavy duty aluminium captive track suitable for horizontal wall and floor mounting. Compatible with strap assemblies with 5012, 5013, 5014, 5018 & 5030 end fittings. Especially suited for Wheelchair restraint systems, computer transport, air cargo and public address system rigging.</p>			
Art.nr.	Length in mm	Material	Weight
5008SPEC	3000	Aluminium	1 ⁹ kg

